



MOSAICO

Multi-layer Orchestration for Secured and low latency applICatiOns

Bertrand Mathieu - Orange Labs

(bertrand2.mathieu@orange.com)

Cloud Days - 24/11/2020



Context and problem statement



- Emergence of services with very strong constraints
 - Latency cannot exceed a few milliseconds
 - End-to-end security should be preserved
- Programmability has become increasingly important in network architectures
 - NFV, OpenFlow, P4
 - Each one exhibits advantages and limitations related its environment : execution time, resource consumption, protocol stack layer, ease of deployment, configuration, migration, etc.
- Networking functions composed of micro-services at control-plane and data-plane
 - => Need for a multi-level and multi-technology orchestration of high-performance micro-services

Objectives of MOSAICO



- Identify network functions to convert a monolithic low-latency secure application into micro-services
- Define orchestration solutions enabling the choreography of micro-services, deployed over heterogeneous technologies
- Select the optimal placement of micro-services to guarantee security, performance and troubleshooting objectives.

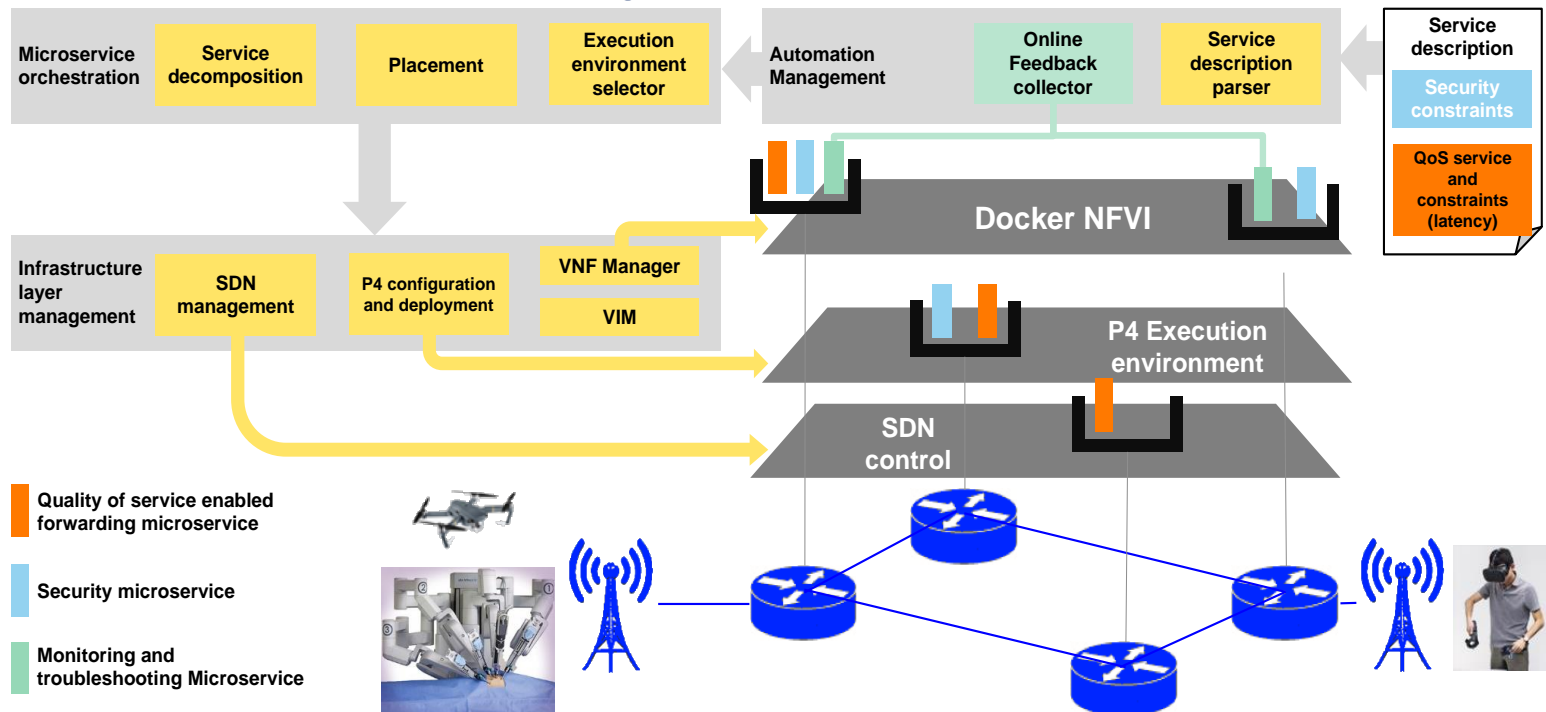

Preliminary version of Orchestrator (1/2)



- Example of Deployment scenario
- For deploying VNFs (later P4 programs to be added)
- Currently relying on OpenMano, OpenStack, Onos

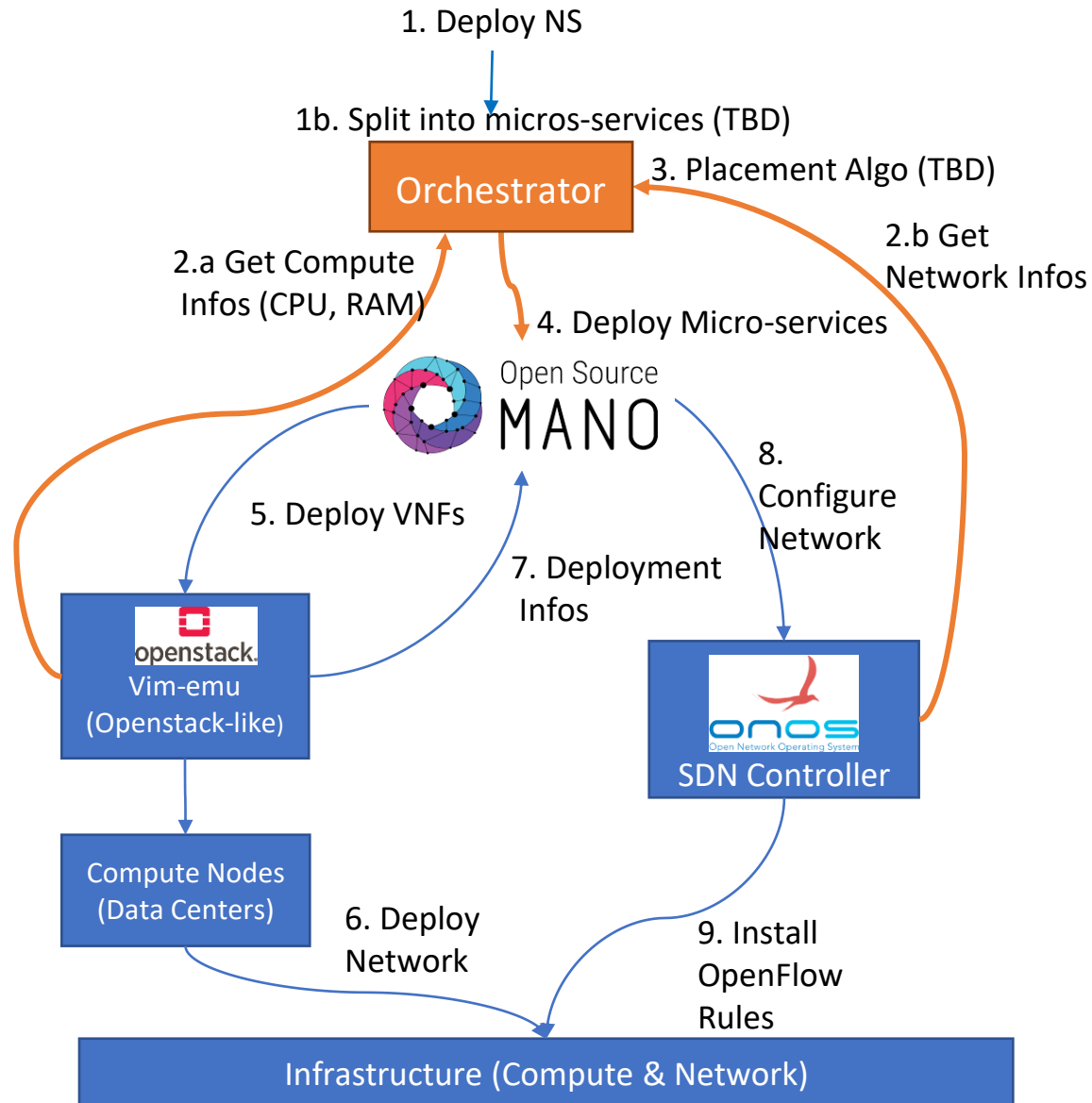

Preliminary version of Orchestrator (2/2)



- Example of a security VNF: Mitigation Attack scenario, by dropping packets from attackers

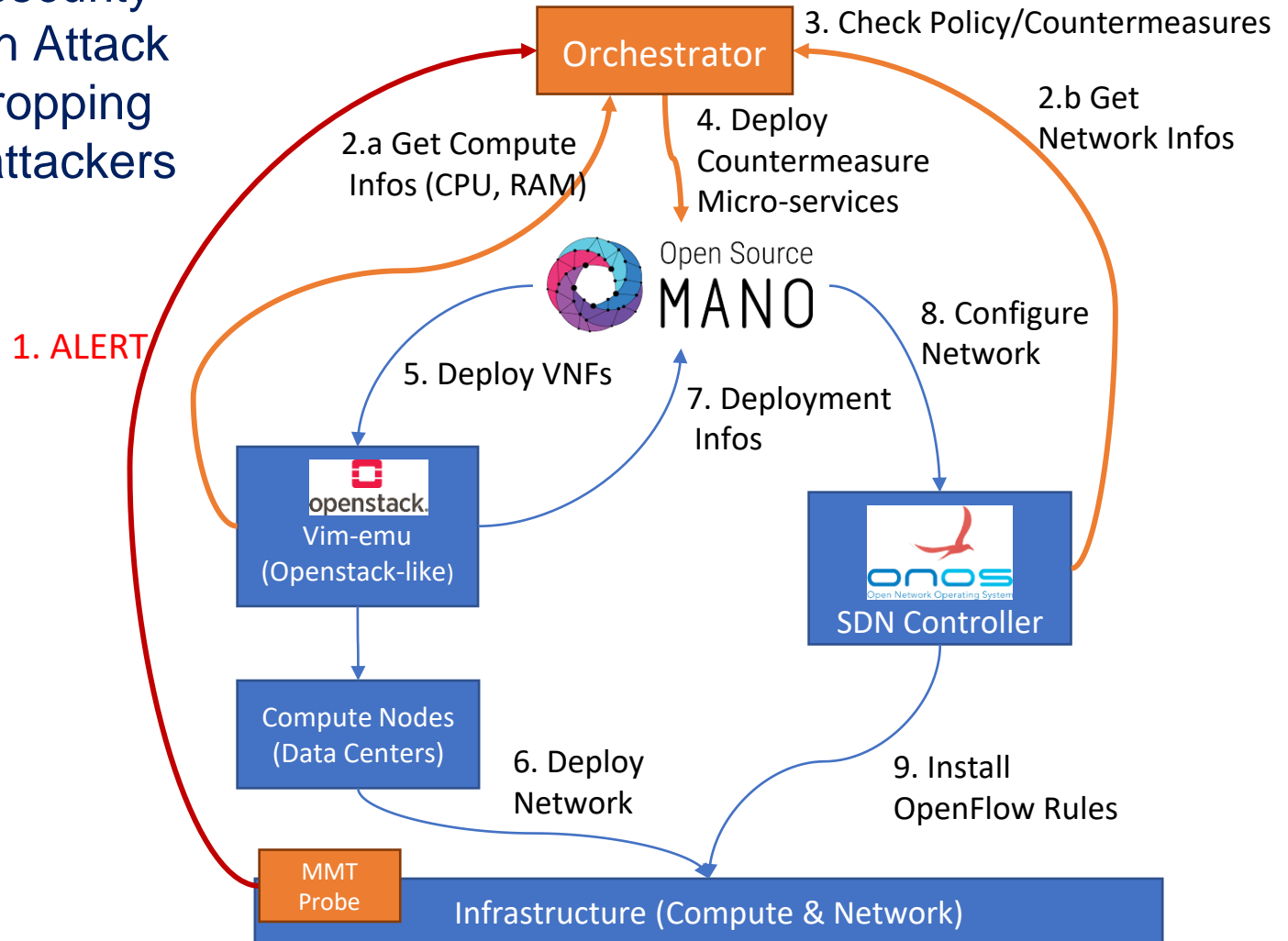

P4 micro-services : Example of a QoS module



- End-to-end latency can be addressed at different locations: endpoints (soft & hard), network physical capacity, network equipment

- We propose a queueing and forwarding system :
 - deployed in network equipment
 - for transmitting LL packets in a short time, as expected by the services
 - while not starving other traffic
 - following IETF L4S (Low Latency, Low Loss, Scalable Throughput Internet Service) proposal

- We propose to rely on a programmable network approach :
 - the P4 framework to deploy and dynamically configure the network equipment for packet processing

P4 : Brief concepts

- Open-source Consortium (p4.org)
- Data Plane Programmability
- Based on match-action tables, configurable by interfaces (controllers)
- Parsing of packet information
- A basic software switch provided by P4 (BMv2)

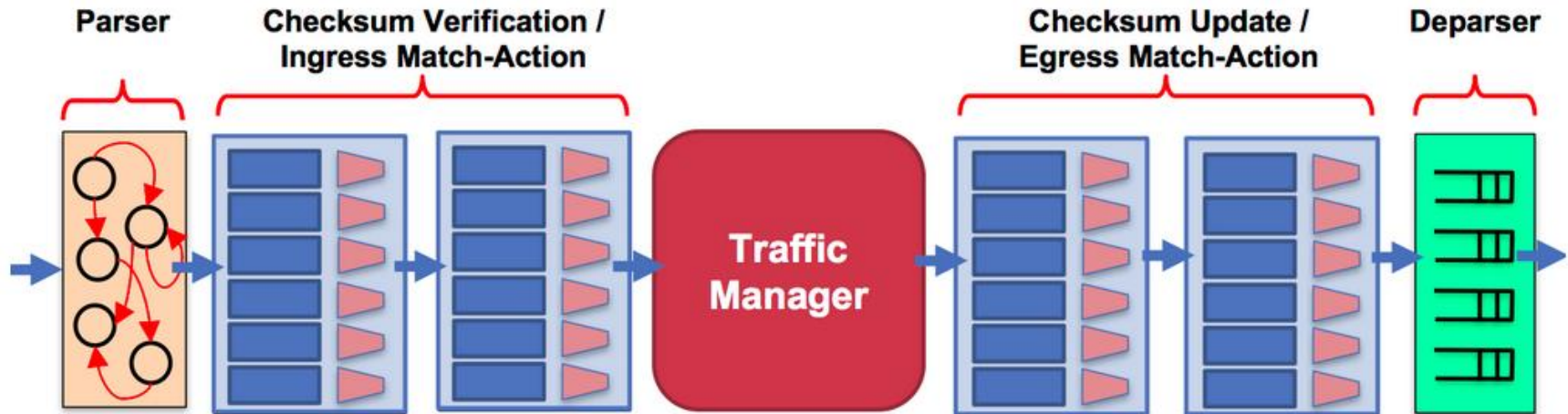

P4-based L4S instantiation

- Traffic separation (Low Latency, Classic) based on ECN bits in the Ingress
- A dual-coupled AQM in the Traffic Manager : for LL (linear AQM), for Classic (PI2 AQM), with 2 latency targets
- AQM computations (probability to forward/mark/drop packet) & Decision in the Egress
- Goal to equally share bandwidth, to avoid LL traffic to starve classic traffic

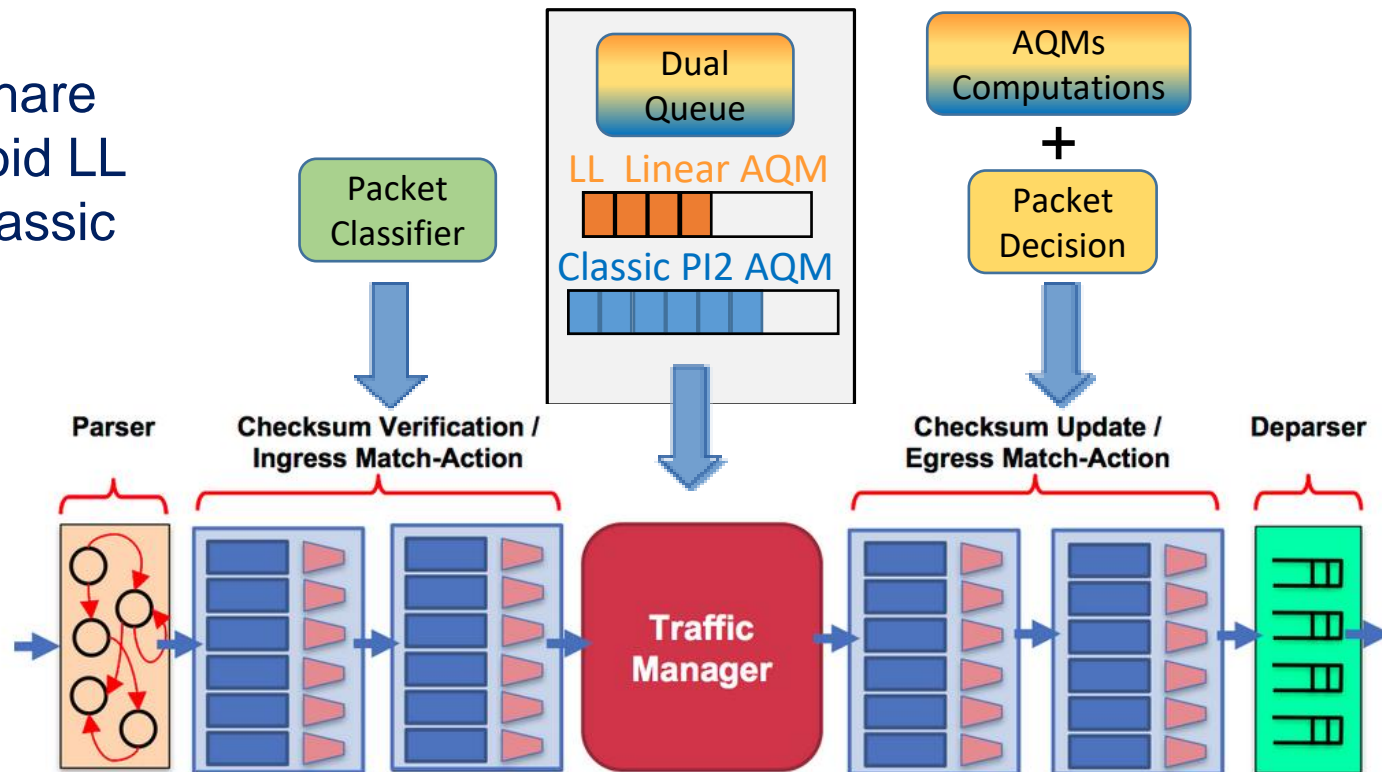

Evaluation : Testbed

- Virtual machines (KVM/QEMU) for clients/servers
- Linux-based BMv2 modified P4 L4S Switch
- 1 “classic” connection, 1 LL TCP-Prague connection (with Accurate ECN) NetEm to introduce link delay
- 2 types of traffic : web (HTTP) or simulated traffic (Iperf)
- 5 measured information : queue delay, queue occupancy, number of marked/dropped packets, throughput

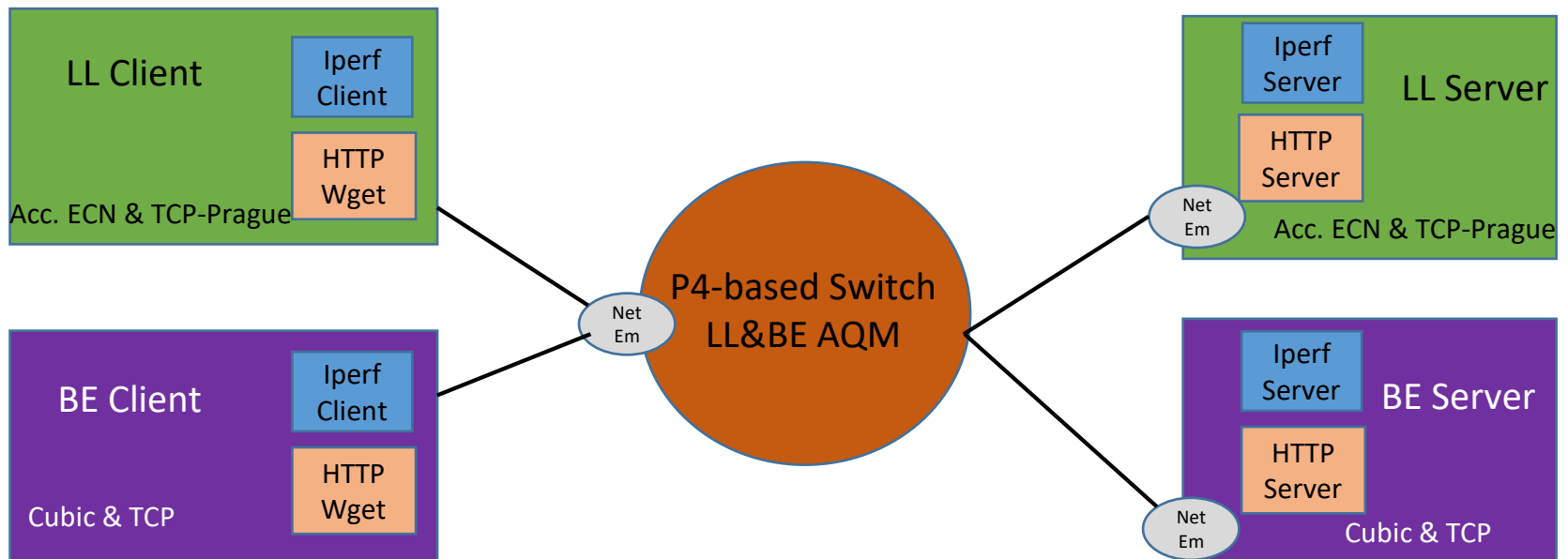

Evaluation : Results (1/2)

- LL (Accurate ECN) packets in L4S queue spent short time (as expected) and quite stable.
- Classic packets in Classic queue spent more time, more variable along time

CDF-Latence-LL-5ms-12bw-iperf3-P4 — purple line
 CDF-Latence-BE-5ms-12bw-iperf3-P4 — green line
 CDF-Latence-LL-5ms-12bw-iperf3-Linux — blue line
 CDF-Latence-BE-5ms-12bw-iperf3-Linux — orange line

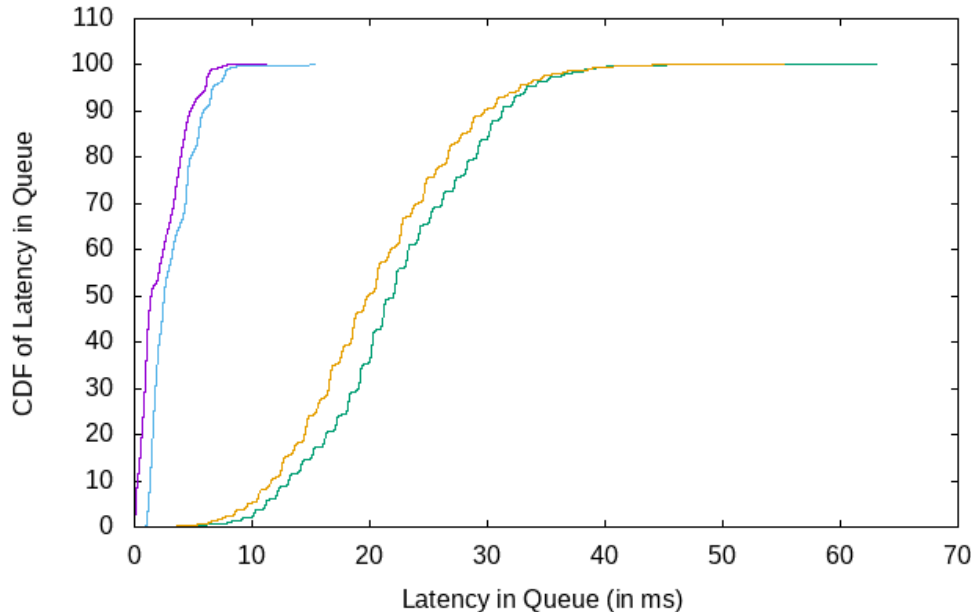

Latence-BE-12bw-5ms-iperf3.txt — purple '+' markers
 Latence-LL-12bw-5ms-iperf3.txt — green 'x' markers

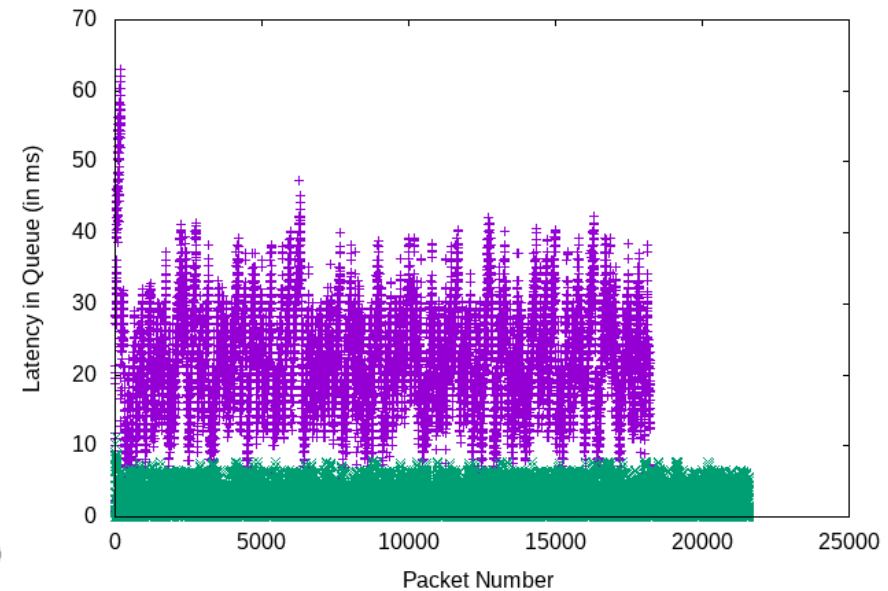

Evaluation : Results (2/2)

- Queue size in LL queue very small and stable (in this config, LL delay 5ms, BW : 12 Mbit => 1 or 2 packets max)
- Higher queue size in Classic queue (less constrained delay) and more variable.
- Outgoing throughput almost equally shared when 2 traffic to be forwarded

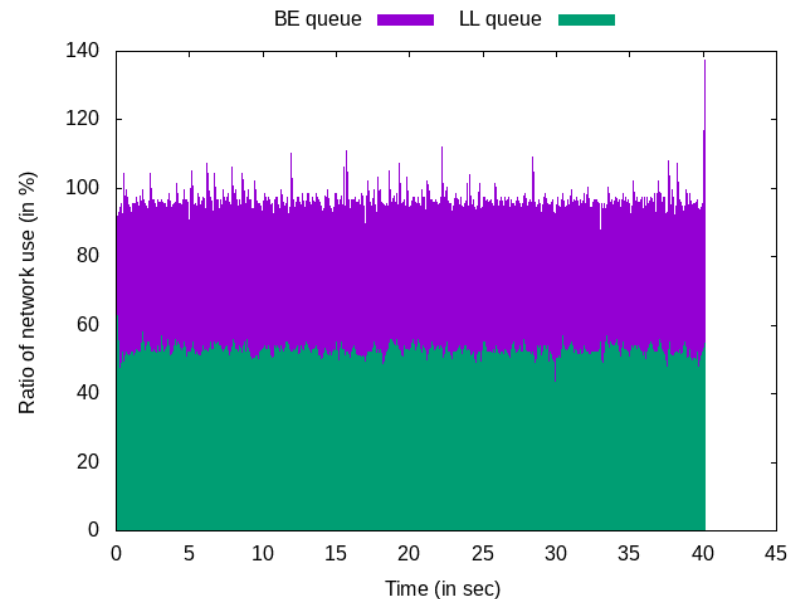
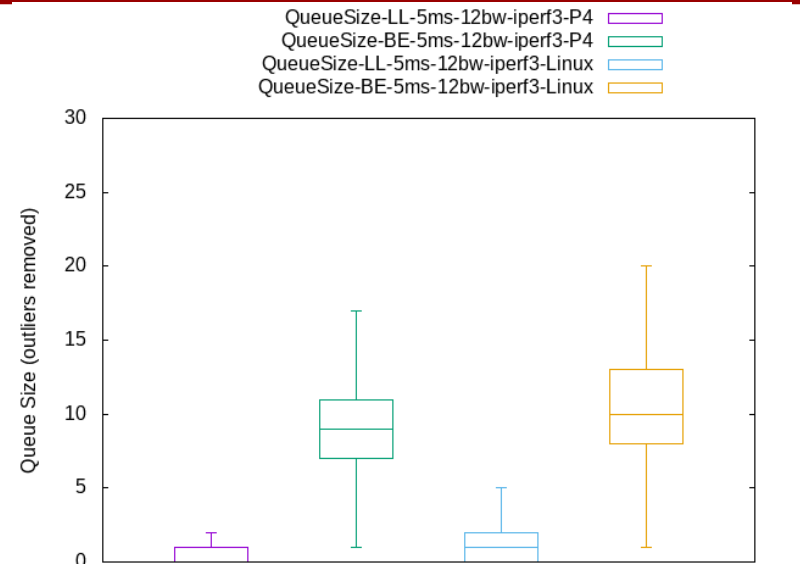

Conclusion



- Ongoing works of the MOSAICO project
- First version of a global orchestrator, integrating existing open sources solution (OpenMano, Onos, etc.)
- First VNF for security attack mitigation
- First implemented P4 module for QoS
- Future work to include P4 deployment into the global orchestrator
- Define a common interface for deploying VNFs and P4 programs
- MOSAICO Website : www.mosaico-project.org

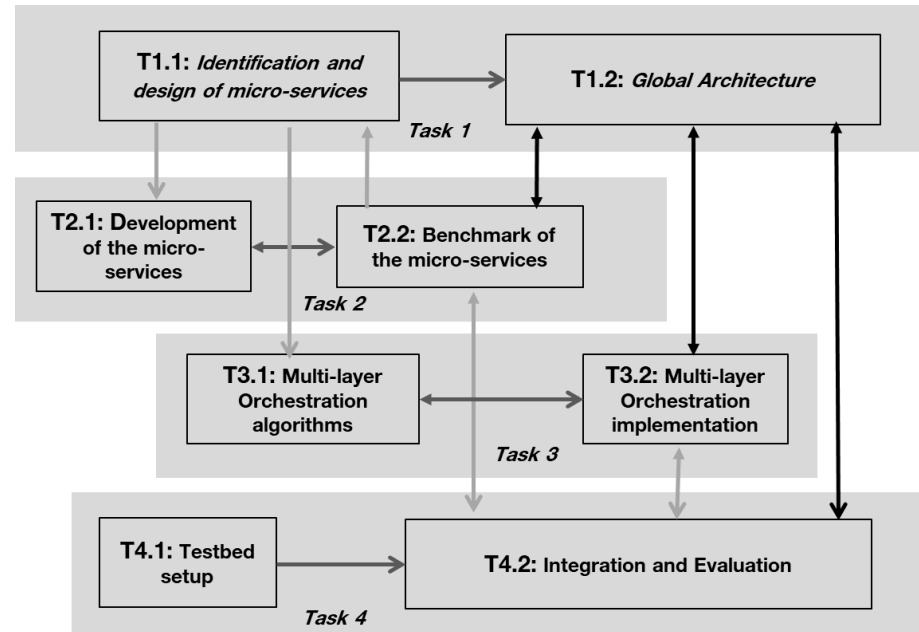

Questions



Q & A